



**Television  
Systems Limited**

**TallyMan**

THE ONLY TALLY SYSTEM YOU'LL EVER NEED

## Tallyman Controller Installation Manual

## Contents

Introduction .....	4
Installation .....	5
TM1 .....	5
Connections .....	5
Pin out details .....	6
Default IP.....	10
Initial setup .....	10
TM2 .....	13
Connections .....	13
Pin out details .....	14
Default IP.....	18
Initial setup .....	18
TM2+ .....	21
Connections .....	21
Pin out details .....	22
Default IP.....	28
Initial setup .....	28
TMC-1.....	31
Connections .....	31
Pin out details .....	32
Default IP.....	34
Initial setup .....	34
Specification.....	35
TM1 .....	35
Internal Power Supply Specification.....	35
TM2 .....	36
Internal Power Supply Specification.....	36
TM2+ .....	38
Internal Power Supply Specification.....	38
TMC-1.....	39
Internal Power Supply Specification.....	39
Motherboard.....	40
CPU.....	40

Memory.....	40
Disk Drive (Solid state) .....	40
Safety .....	41
Installation .....	41
Earthing/Grounding .....	41
Mounting.....	41
Power .....	41
Ventilation.....	41
EC Declaration of conformity .....	42
Warranty, Maintenance and Repair .....	43
Failure during warranty .....	43
Technical support information .....	43
TSL Returns Procedure.....	43
Fault report details required.....	43
Packing .....	43

## Introduction

The following document covers installation of the TSL Tallyman controllers TM1, TM2, TM2+ and TMC-1.

The TSL tally system consists of a number of displays, either discrete modules or Multiviewers / IMD (In-Picture-Display); controlled by a 19" 1RU remotely located TallyMan Controller.

The TallyMan Controller distributes power and provides the control for the displays. It also carries user-defined interfaces for routing matrices, vision mixers and output drivers for cue lights and additional tally control for cameras etc.

All operational set-ups such as the router assignments, mnemonics and tally routing are programmed with a set-up computer running another version of TallyMan normally connected to the Ethernet Port on the TallyMan Controller except in the case of the TMC-1 that is configured locally.

[Back to Top ^](#)

# Installation

## TM1



The TallyMan controller should be installed in a standard 19" rack with good ventilation, no other special precautions need be taken, further information regarding earthing, mounting, power etc may be found in the [Safety](#) section.

### Connections

- Tally 1** This is for the parallel tallies. 1 – 32
- Tally 2** This is for the parallel tallies 33 – 64
- Control 1** RS422 – User Assignable. Used for Mixer/Router/Multiviewer connection
- Control 2** RS422 – User Assignable. Used for Mixer/Router/Multiviewer connection
- Control 3** RS232 – User Assignable. Used for Serial configuration of Controller Network settings and available for Mixer/Router/Multiviewer connection
- Control 4** RJ45 UMD Display Ports - Power and RS422 serial data is available from these ports.
- Ethernet** This is for configuration via the configuration PC and network comms with IP capable devices.
- Power** The unit is powered via an IEC 60320 C14 coupler. The inlet is auto ranging 100-240V. No cable is supplied with this device.

[Back to Top ^](#)

## Pin out details

### Ethernet

The cable required to connect the TM1 controller with the configuring computer is as follows:

Signal Name	RJ-45 Ethernet Pin Numbers	Crossover Cable Pinouts
TX +	1	3
TX -	2	6
RX +	3	1
FPWR + Power	4	4
FPWR + Power	5	5
RX -	6	2
FPWR - Power	7	7
FPWR - Power	8	8

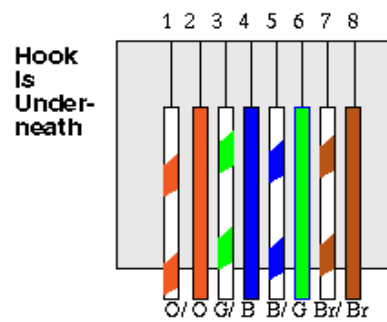

For a hub connection, use a straight-through cable. For TallyMan Controller to Computer, use a crossover cable

[Back to Top ^](#)

## Control Ports

Control ports 1 and 2 – Serial RS422

Pin Numbers	Signal	Pin Numbers	Signal
1	0v/Chassis	6	0v
2	TX-	7	TX+
3	RX+	8	RX-
4	0v	9	0v
5	-		

Control Port 3 – Serial RS232 (Maintenance port)

Pin Numbers	Signal	Pin Numbers	Signal
1	-	6	-
2	RX	7	RTS
3	TX	8	CTS
4	DTR	9	-
5	0v		

Control Port 4 - Serial RS422 Display Ports

RJ45 DISPLAY CONNECTORS	
1	0v
2	0v
3	RX-
4	TX+
5	TX-
6	RX+
7	+24v
8	+24v

The Display ports are wired pin to pin, all 8 display ports are paralleled and are addressed as port 4.

UMD displays should be distributed evenly between the eight display drive outputs on the TM1 controller. Cables to the UMDs should be screened CAT5 cable, in order to conform to European CE requirements it is recommended that CAT5E FTP cable is used.

[Back to Top ^](#)

*Parallel Tally connectors*

TALLY 1 & 2 INPUT/OUTPUT CONNECTORS			
D37 SOCKET			
1	TALLY 1	20	TALLY 20
2	TALLY 2	21	TALLY 21
3	TALLY 3	22	TALLY 22
4	TALLY 4	23	TALLY 23
5	TALLY 5	24	TALLY 24
6	TALLY 6	25	TALLY 25
7	TALLY 7	26	TALLY 26
8	TALLY 8	27	TALLY 27
9	TALLY 9	28	TALLY 28
10	TALLY 10	29	TALLY 29
11	TALLY 11	30	TALLY 30
12	TALLY 12	31	TALLY 31
13	TALLY 13	32	TALLY 32
14	TALLY 14	33	0v
15	TALLY 15	34	+12 / +24V see note
16	TALLY 16	35	Ext Voltage Ref Pin
17	TALLY 17	36	0v
18	TALLY 18	37	-
19	TALLY 19		

Parallel (GPI) tallies are connected directly to the Tally 1 and Tally 2 D37 connectors on the TM1 controller.

These are freely assignable as inputs or outputs in groups of eight. Tally inputs will occupy the lowest numbered pins starting with the Tally 1 connector. The output parallel tallies (if any are assigned) will start from the next available pin on the D37 connector.

The following tally in/ out arrangements are possible between the Tally 1 and Tally 2 connectors:

Inputs	Outputs
0	64
8	56
16	48
24	40
32	32
40	24
48	16
56	8
64	0



## Tally inputs

A ground or 0V to the pin is required to activate a tally input. The common or ground connection is connected to pin 36.

## Tally outputs

Tally outputs consist of open collector driver circuits. Common (ground) appears on pin 36. The circuit is capable of sinking approximately 150mA to ground to activate relays etc.

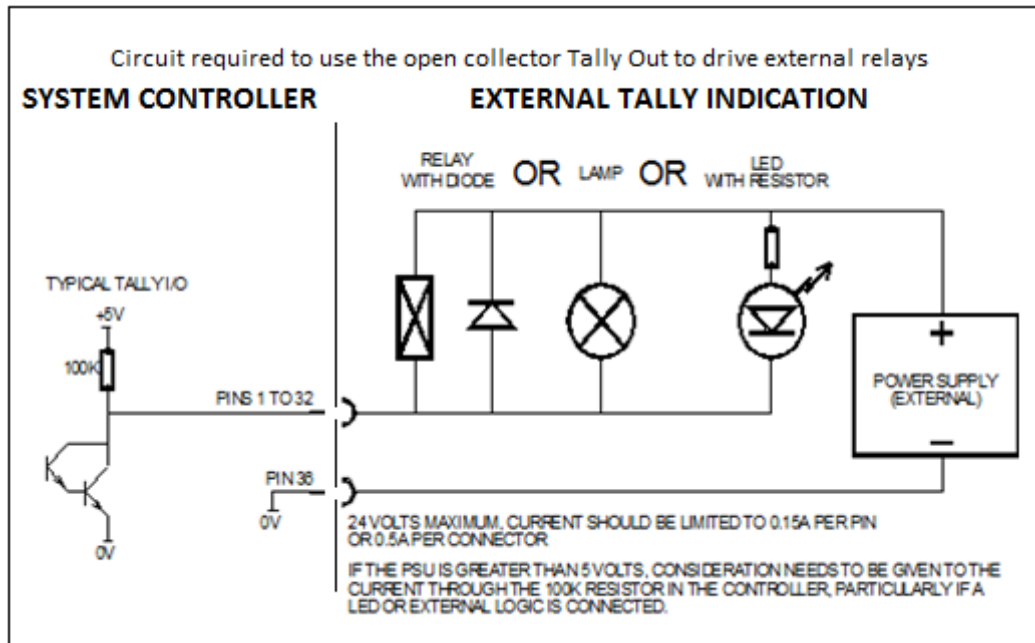

### Notes:

- 1) Pin 34 carries a +12 V, or from Serial Number: 66200 +24V supply rated at 0.5A. Do not use this internal +12V for relay coil supply.
- 2) Pin 35

LK1 on the internal EAB2 cards is set for the pull-up resistors to be referenced to normally + 5V or, by changing the link to positions Centre/Ext, an external voltage reference applied to Pin 35 on the D37 connector.

If using an external voltage above 5V, the link on the card should be set for external pull-up (position 2-3, labelled EXT, away from the D37), and the external voltage should be applied to Pin 35. Putting the link to EXT and applying the voltage to Pin 35 also enables the onboard spike suppression diodes.

[Back to Top ^](#)

## Default IP

The default IP parameters of TSL Tallyman controllers are:

IP Address: 192.168.205.121

Subnet Mask: 255.255.255.0

Connection for configuration purposes is via a PC running TallyMan, available for download from the TSL website [www.TSL.co.uk](http://www.TSL.co.uk)

## Initial setup

Connect a PC running a terminal program (Hyper terminal/Putty/Tera Term Pro for example) to the Maintenance Port, Port 3 on the TallyMan controller.

## HyperTerminal Settings

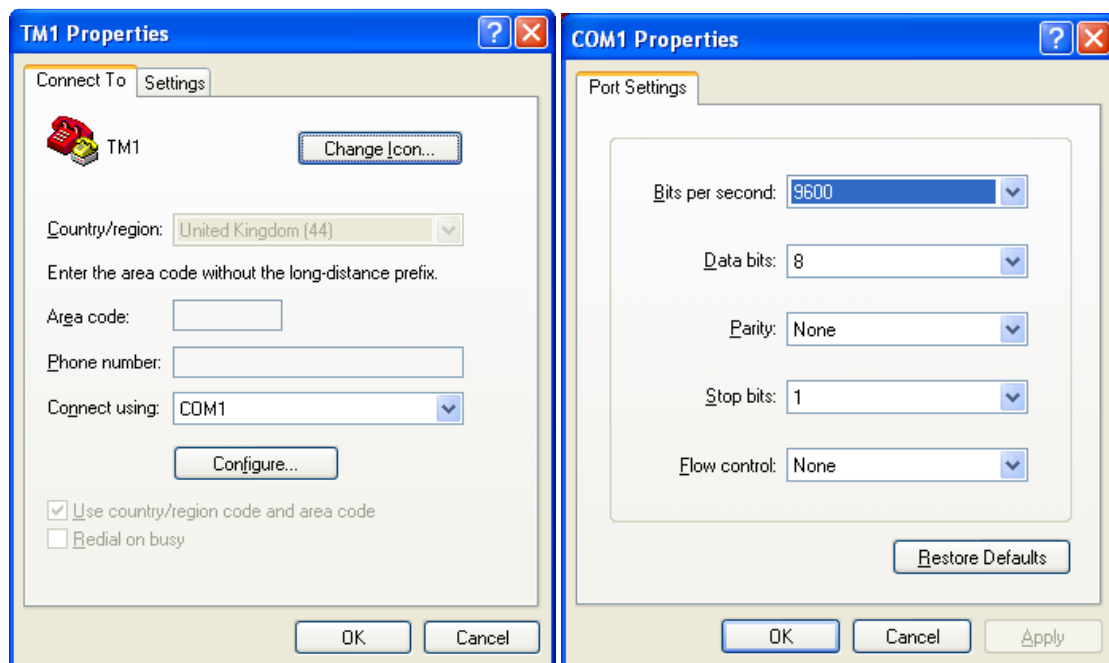

```

TMx - HyperTerminal
File Edit View Call Transfer Help
Revert to factory software? (Y to downgrade):
Enter IP Address:
Enter IP Subnet:
Enter IP Gateway:
System starting. Goodbye!

TallyMan startup: change parameters? (Press Y in 1 sec)

Current IP Address: 192.168.100.220
Current Subnet Mask: 255.255.255.0
Current Gateway: 0.0.0.0

Set as main (S)ystem or remote (C)ontroller?:
Configured as Main System!

Set as Redundant Backup? (B to set):
Delete system data file? (D to delete):
Revert to factory software? (Y to downgrade):
Enter IP Address: 192.168.100.220
Enter IP Subnet: 255.255.255.0
Enter IP Gateway: 0.0.0.0
Saving... _

Connected 00:01:07 Auto detect 9600 8-N-1 SCROLL CAPS NUM Capture Print echo

```

Start HyperTerminal and then power up the TM1 and wait for about 10 seconds. Press Y on the keyboard within 1 sec of the message appearing. Follow the on-screen instruction

- Pressing **S** or Enter on the PC's keyboard will set the TallyMan units as the Main Unit
- Pressing **C** will set it as a Controller so that it may be an Object in the system tree under a Main Controller, this is not necessary to share objects and tally information between controllers, more information on object sharing can be found in the sharing objects section of the TallyMan configuration manual.
- Pressing **B** will set the unit as a Redundant Backup unit. See the section on Backup for information on how to use this facility.
- Pressing **D** will delete the current setup file; pressing any other key will allow access to the IP settings.
- Pressing **Y** will revert the unit to factory software and will downgrade the unit to the previous version of the TallyMan Program provided that an upgrade has taken place in the field.
- IP Addresses are set as shown. If no entry is made and Enter in the PC's keyboard is pressed the original settings will be kept.

When all settings are correct remove the RS232 cable and re-power the unit.

**Notes.**

Use the following cable to connect your PC comm. Port to Port 3 of the TallyMan:

<b>PC</b>	<b>TM1</b>
2	3
3	2
5	5

[Back to Top ^](#)

## TM2



The TallyMan controller should be installed in a standard 19" rack with good ventilation, no other special precautions need be taken, further information regarding earthing, mounting, power etc may be found in the [Safety](#) section.

### Connections

<b>Tally 1</b>	This is for the parallel tallies.	1 – 32
<b>Tally 2</b>	This is for the parallel tallies	33-64
<b>Tally 3</b>	This is for the parallel tallies	65-96
<b>Tally 4</b>	This is for the parallel tallies	97-128
<b>Control 1</b>	RS422 – User Assignable. Used for Mixer/Router/Multiviewer connection	
<b>Control 2</b>	RS422 – User Assignable. Used for Mixer/Router/Multiviewer connection	
<b>Control 3</b>	RS232 – User Assignable. Used for Serial configuration of Controller Network settings and available for Mixer/Router/Multiviewer connection	
<b>Control 4</b>	RJ45 UMD Display Ports - Power and RS422 serial data is available from these ports.	
<b>Control 5</b>	RS422 – User Assignable. Used for Mixer/Router/Multiviewer connection	
<b>Control 6</b>	RS422 – User Assignable. Used for Mixer/Router/Multiviewer connection	
<b>Control 7</b>	RS422 – User Assignable. Used for Mixer/Router/Multiviewer connection	
<b>Ethernet</b>	This is for configuration via the configuration PC and network comms with IP capable devices.	
<b>Power</b>	The unit is powered via an IEC 60320 C14 coupler. The inlet is auto ranging 100-240V. No cable is supplied with this device.	

[Back to Top ^](#)

## Pin out details

### Ethernet

The cable required to connect the TM2 controller with the configuring computer is as follows:

Signal Name	RJ-45 Ethernet Pin Numbers	Crossover Cable Pinouts
TX +	1	3
TX -	2	6
RX +	3	1
FPWR + Power	4	4
FPWR + Power	5	5
RX -	6	2
FPWR - Power	7	7
FPWR - Power	8	8

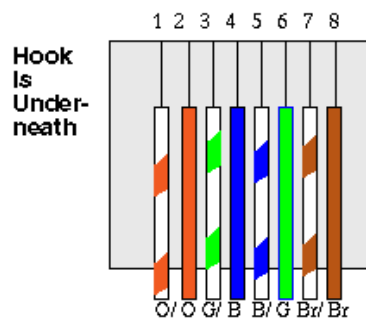

For a hub connection, use a straight-through cable. For TallyMan Controller to Computer, use a crossover cable

[Back to Top ^](#)

## Control Ports

Control ports 1,2,5,6 & 7 – Serial RS422

Pin Numbers	Signal	Pin Numbers	Signal
1	0v/Chassis	6	0v
2	TX-	7	TX+
3	RX+	8	RX-
4	0v	9	0v
5	-		

Control Port 3 – Serial RS232 (Maintenance port)

Pin Numbers	Signal	Pin Numbers	Signal
1	-	6	-
2	RX	7	RTS
3	TX	8	CTS
4	DTR	9	-
5	0v		

Control Port 4 - Serial RS422 Display Ports

RJ45 DISPLAY CONNECTORS	
1	0v
2	0v
3	RX-
4	TX+
5	TX-
6	RX+
7	+24v
8	+24v

The Display ports are wired pin to pin, all 8 display ports are paralleled and are addressed as port 4.

UMD displays should be distributed evenly between the eight display drive outputs on the TM2 controller. Cables to the UMDs should be screened CAT5 cable, in order to conform with European CE requirements it is recommended that CAT5E FTP cable is used

[Back to Top ^](#)

*Parallel Tally connectors*

TALLY 1,2,3 & 4 INPUT/OUTPUT CONNECTORS			
D37 SOCKET			
1	TALLY 1	20	TALLY 20
2	TALLY 2	21	TALLY 21
3	TALLY 3	22	TALLY 22
4	TALLY 4	23	TALLY 23
5	TALLY 5	24	TALLY 24
6	TALLY 6	25	TALLY 25
7	TALLY 7	26	TALLY 26
8	TALLY 8	27	TALLY 27
9	TALLY 9	28	TALLY 28
10	TALLY 10	29	TALLY 29
11	TALLY 11	30	TALLY 30
12	TALLY 12	31	TALLY 31
13	TALLY 13	32	TALLY 32
14	TALLY 14	33	0v
15	TALLY 15	34	+12 / +24V see note
16	TALLY 16	35	Ext Voltage Ref Pin
17	TALLY 17	36	0v
18	TALLY 18	37	-
19	TALLY 19		

Parallel (GPI) tallies are connected directly to the Tally 1, 2, 3 & 4 D37 connectors on the TM2 controller.

These are freely assignable as inputs or outputs in groups of eight. Tally inputs will occupy the lowest numbered pins starting with the Tally 1 connector. The output parallel tallies (if any are assigned) will start from the next available pin on the D37 connector.

The following tally in/out arrangements are possible between the Tally 1 and Tally 2 connectors:

Inputs	Outputs
0	64
8	56
16	48
24	40
32	32
40	24
48	16
56	8
64	0



## Tally inputs

To activate a Tally input, pull the relevant pin to ground or 0V. The common or ground connection is connected to pin 36.

## Tally outputs

Tally outputs consist of open collector driver circuits. Common (ground) appears on pin 36. The circuit is capable of sinking approximately 150mA to ground to activate relays etc.

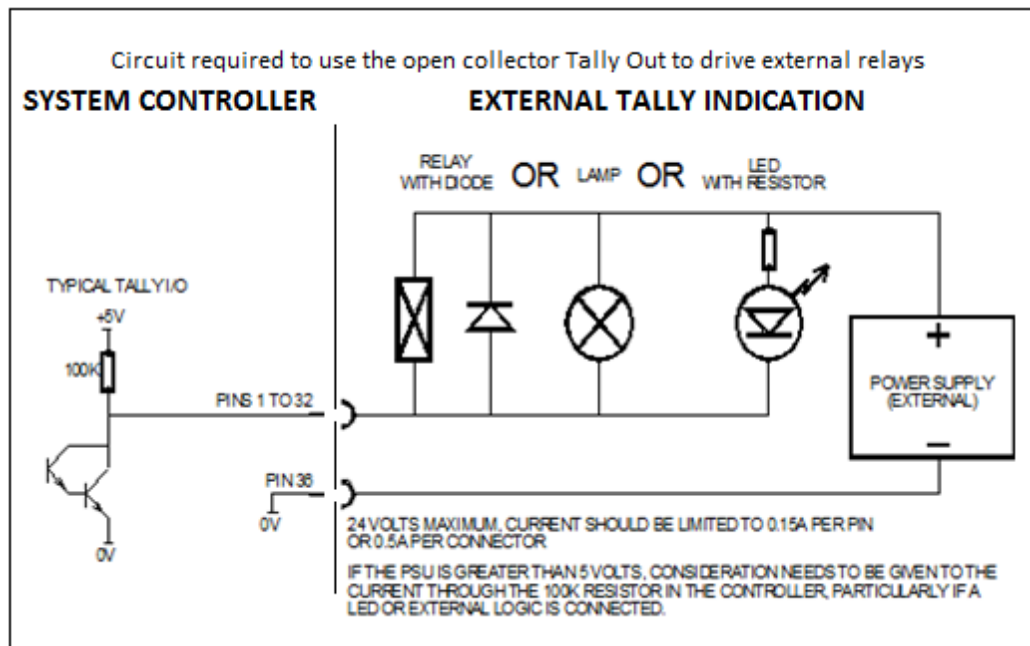

### Notes:

- 1) Pin 34 carries a +12 V, or from Serial Number: 66200 +24V supply rated at 0.5A. Do not use this internal +12V for relay coil supply.
- 2) Pin 35

LK1 on the internal EAB2 cards is set for the pull-up resistors to be referenced to normally + 5V or, by changing the link to positions Centre/Ext, an external voltage reference applied to Pin 35 on the D37 connector.

If using an external voltage above 5V, the link on the card should be set for external pull-up (position 2-3, labelled EXT, away from the D37), and the external voltage should be applied to Pin 35. Putting the link to EXT and applying the voltage to Pin 35 also enables the onboard spike suppression diodes.

[Back to Top ^](#)

## Default IP

The default IP parameters of TSL Tallyman controllers are:

IP Address:	192.168.205.121
Subnet Mask:	255.255.255.0

Connection for configuration purposes is via a PC running TallyMan, available for download from the TSL website [www.TSL.co.uk](http://www.TSL.co.uk)

## Initial setup

Connect a PC running a terminal program (Hyper terminal/Putty/Tera Term Pro for example) to the Maintenance Port, Port 3 on the TallyMan controller.

## HyperTerminal Settings

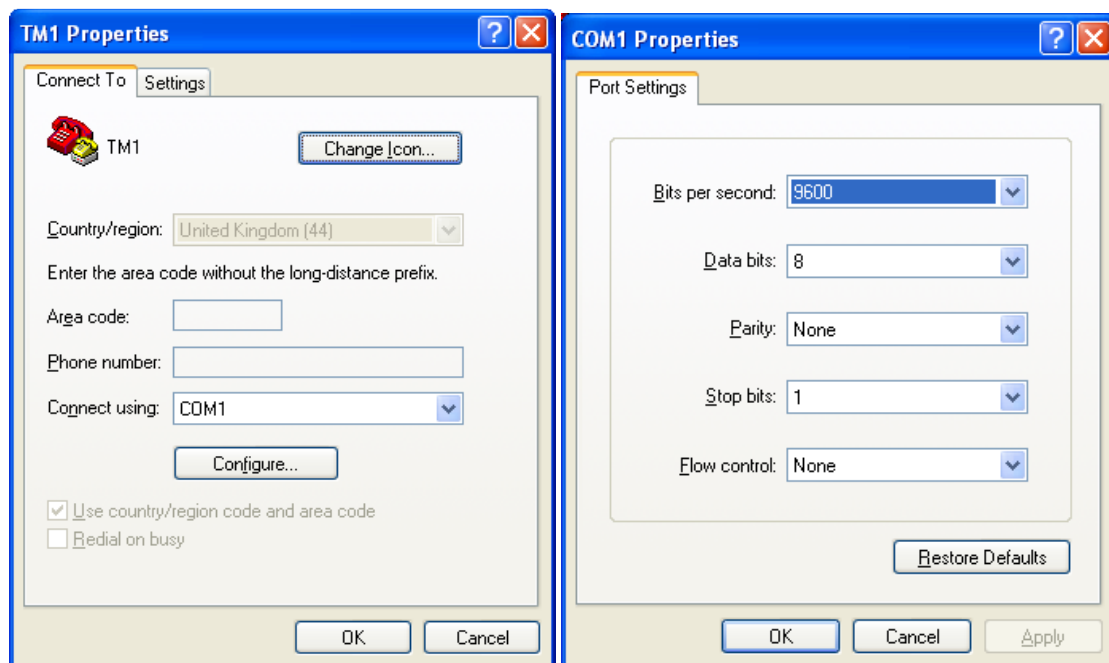

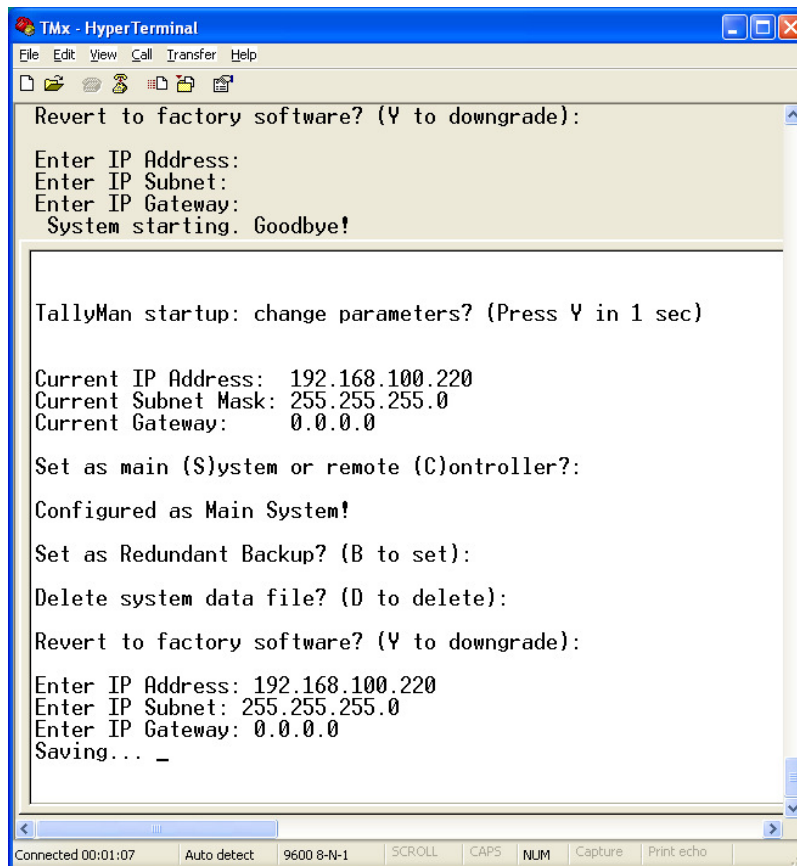

Start HyperTerminal and then power up the TM2 and wait for about 10 secs. Press Y on the keyboard within 1 sec of the message appearing. Follow the on-screen instruction

- Pressing **S** or Enter on the PC's keyboard will set the TallyMan units as the Main Unit
- Pressing **C** will set it as a Controller so that it may be an Object in the system tree under a Main Controller, this is not necessary to share objects and tally information between controllers, more information on object sharing can be found in the sharing objects section of the TallyMan configuration manual.
- Pressing **B** will set the unit as a Redundant Backup unit. See the section on Backup for information on how to use this facility.
- Pressing **D** will delete the current setup file; pressing any other key will allow access to the IP settings.
- Pressing **Y** will revert the unit to factory software and will downgrade the unit to the previous version of the TallyMan Program provided that an upgrade has taken place in the field.
- IP Addresses are set as shown. If no entry is made and Enter in the PC's keyboard is pressed the original settings will be kept.

When all settings are correct remove the RS232 cable and re-power the unit.

### Notes.

Use the following cable to connect your PC comm. Port to Port 3 of the TallyMan:

<b>PC</b>	<b>TM2</b>
2	3
3	2
5	5

[Back to Top ^](#)

## TM2+



The TallyMan controller should be installed in a standard 19" rack with good ventilation, no other special precautions need be taken, further information regarding earthing, mounting, power etc may be found in the [Safety](#) section.

### Connections

<b>Tally 1</b>	This is for the parallel input tallies.	1 – 32
<b>Tally 2</b>	This is for the (isolated relay) parallel output tallies	1-16
<b>Tally 3</b>	This is for the (isolated relay) parallel output tallies	17-32
<b>Tally 4</b>	This is for the (isolated relay) parallel output tallies	33-48
<b>Control 1</b>	RS422 – User Assignable. Used for Mixer/Router/Multiviewer connection	
<b>Control 2</b>	RS422 – User Assignable. Used for Mixer/Router/Multiviewer connection	
<b>Control 3</b>	RS232 – User Assignable. Used for Serial configuration of Controller Network settings and available for Mixer/Router/Multiviewer connection	
<b>Control 4</b>	RJ45 UMD Display Ports - Power and RS422 serial data is available from these ports.	
<b>Control 5</b>	RS422 – User Assignable. Used for Mixer/Router/Multiviewer connection	
<b>Control 6</b>	RS422 – User Assignable. Used for Mixer/Router/Multiviewer connection	
<b>Control 7</b>	RS422 – User Assignable. Used for Mixer/Router/Multiviewer connection	
<b>Control 8</b>	RS422 – User Assignable. Used for Mixer/Router/Multiviewer connection	
<b>Ethernet</b>	This is for configuration via the configuration PC and network comms with IP capable devices.	
<b>Power</b>	The unit is powered via an IEC 60320 C14 coupler. The inlet is auto ranging 100-240V. No cable is supplied with this device.	

[Back to Top ^](#)

## Pin out details

### Ethernet

The cable required to connect the TM2+ controller with the configuring computer is as follows:

Signal Name	RJ-45 Ethernet Pin Numbers	Crossover Cable Pinouts
TX +	1	3
TX -	2	6
RX +	3	1
FPWR + Power	4	4
FPWR + Power	5	5
RX -	6	2
FPWR - Power	7	7
FPWR - Power	8	8

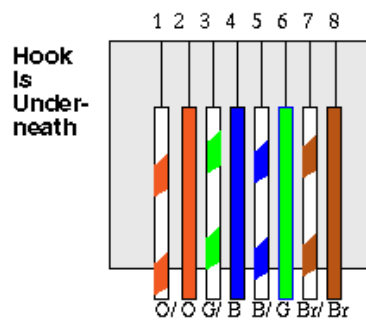

For a hub connection, use a straight-through cable. For TallyMan Controller to Computer, use a crossover cable

[Back to Top ^](#)

### Control Ports

Control ports 1,2,5,6, 7 & 8 – Serial RS422

Pin Numbers	Signal	Pin Numbers	Signal
1	0v/Chassis	6	0v
2	TX-	7	TX+
3	RX+	8	RX-
4	0v	9	0v
5	-		

Control Port 3 – Serial RS232 (Maintenance port)

Pin Numbers	Signal	Pin Numbers	Signal
1	-	6	-
2	RX	7	RTS
3	TX	8	CTS
4	DTR	9	-
5	0v		

Control Port 4 - Serial RS422 Display Ports

RJ45 DISPLAY CONNECTORS	
1	0v
2	0v
3	RX-
4	TX+
5	TX-
6	RX+
7	+24v
8	+24v

The Display ports are wired pin to pin, all 8 display ports are paralleled and are addressed as port 4.

UMD displays should be distributed evenly between the eight display drive outputs on the TM2+ controller. Cables to the UMDs should be screened CAT5 cable, in order to conform with European CE requirements it is recommended that CAT5E FTP cable is used

[Back to Top ^](#)

### *Parallel Tally connectors*

Parallel (GPI) tallies are connected directly to the Tally 1, 2, 3 & 4 D37 connectors on the TM2+ controller.

#### Tally inputs

To activate a tally input, pull the relevant pin to ground or 0V. The common or ground connection is connected to pin 36.

<b>TALLY 1 INPUT CONNECTORS</b>			
<b>D37 SOCKET</b>			
1	TALLY 1	20	TALLY 20
2	TALLY 2	21	TALLY 21
3	TALLY 3	22	TALLY 22
4	TALLY 4	23	TALLY 23
5	TALLY 5	24	TALLY 24
6	TALLY 6	25	TALLY 25
7	TALLY 7	26	TALLY 26
8	TALLY 8	27	TALLY 27
9	TALLY 9	28	TALLY 28
10	TALLY 10	29	TALLY 29
11	TALLY 11	30	TALLY 30
12	TALLY 12	31	TALLY 31
13	TALLY 13	32	TALLY 32
14	TALLY 14	33	0v
15	TALLY 15	34	+12 / +24V see note
16	TALLY 16	35	Ext Voltage Ref Pin
17	TALLY 17	36	0v
18	TALLY 18	37	-
19	TALLY 19		



## Tally outputs

The Tally Outputs consist of isolated relay contact pairs. Current loading is rated at 0.5A at 125 VAC, 1A at 24 VDC, non-inductive. Common (ground) appears on Pin 36.

The example below demonstrates the circuit required for Tally 33 on the Tally 2 D37 connector, Tally 34 uses pins 3 + 4, Tally out 35 uses pins 5 + 6.

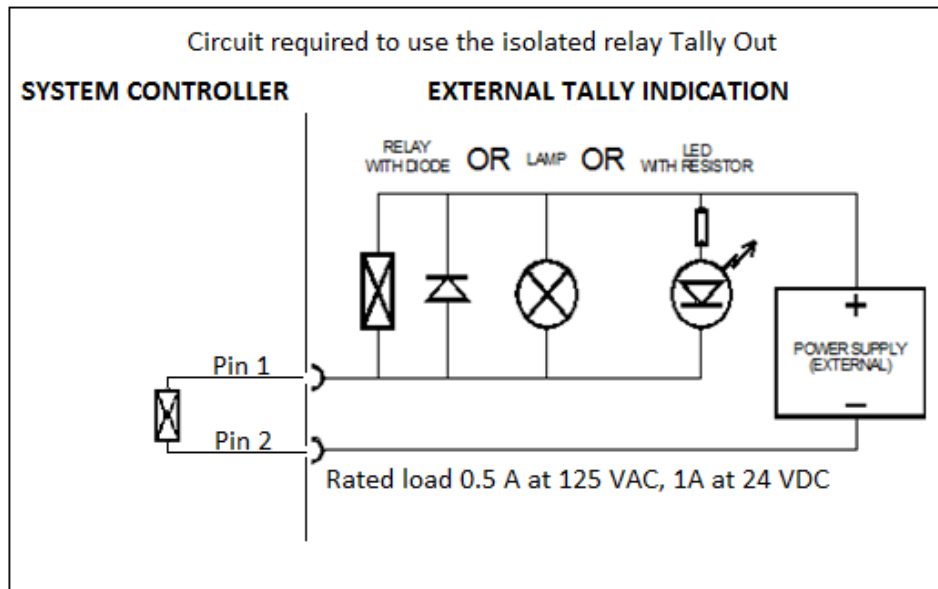

<b>TALLY 2 OUTPUT CONNECTOR D37 SOCKET</b>			
1	TALLY 33	20	TALLY 42
2	TALLY 33	21	TALLY 43
3	TALLY 34	22	TALLY 43
4	TALLY 34	23	TALLY 44
5	TALLY 35	24	TALLY 44
6	TALLY 35	25	TALLY 45
7	TALLY 36	26	TALLY 45
8	TALLY 36	27	TALLY 46
9	TALLY 37	28	TALLY 46
10	TALLY 37	29	TALLY 47
11	TALLY 38	30	TALLY 47
12	TALLY 38	31	TALLY 48
13	TALLY 39	32	TALLY 48
14	TALLY 39	33	0v
15	TALLY 40	34	+24V
16	TALLY 40	35	Ext Voltage Ref Pin
17	TALLY 41	36	0v
18	TALLY 41	37	-
19	TALLY 42		

<b>TALLY 3 OUTPUT CONNECTOR D37 SOCKET</b>			
1	TALLY 49	20	TALLY 58
2	TALLY 49	21	TALLY 59
3	TALLY 50	22	TALLY 59
4	TALLY 50	23	TALLY 60
5	TALLY 51	24	TALLY 60
6	TALLY 51	25	TALLY 61
7	TALLY 52	26	TALLY 61
8	TALLY 52	27	TALLY 62
9	TALLY 53	28	TALLY 62
10	TALLY 53	29	TALLY 63
11	TALLY 54	30	TALLY 63
12	TALLY 54	31	TALLY 64
13	TALLY 55	32	TALLY 64
14	TALLY 55	33	0v
15	TALLY 56	34	+24V
16	TALLY 56	35	Ext Voltage Ref Pin
17	TALLY 57	36	0v
18	TALLY 57	37	-
19	TALLY 58		

<b>TALLY 4 OUTPUT CONNECTOR D37 SOCKET</b>			
1	TALLY 65	20	TALLY 74
2	TALLY 65	21	TALLY 75
3	TALLY 66	22	TALLY 75
4	TALLY 66	23	TALLY 76
5	TALLY 67	24	TALLY 76
6	TALLY 67	25	TALLY 77
7	TALLY 68	26	TALLY 77
8	TALLY 68	27	TALLY 78
9	TALLY 69	28	TALLY 78
10	TALLY 69	29	TALLY 79
11	TALLY 70	30	TALLY 79
12	TALLY 70	31	TALLY 80
13	TALLY 71	32	TALLY 80
14	TALLY 71	33	0v
15	TALLY 72	34	+24V
16	TALLY 72	35	Ext Voltage Ref Pin
17	TALLY 73	36	0v
18	TALLY 73	37	-
19	TALLY 74		

**Notes:**

1) Pin 34 carries a +12 V, or from Serial Number: 66200 +24V supply rated at 0.5A. Do not use this internal +12V for relay coil supply.

2) Pin 35

LK1 on the internal EAB2 cards is set for the pull-up resistors to be referenced to normally + 5V or, by changing the link to positions Centre/Ext, an external voltage reference applied to Pin 35 on the D37 connector.

If using an external voltage above 5V, the link on the card should be set for external pull-up (position 2-3, labelled EXT, away from the D37), and the external voltage should be applied to Pin 35. Putting the link to EXT and applying the voltage to Pin 35 also enables the onboard spike suppression diodes.

[Back to Top ^](#)

## Default IP

The default IP parameters of TSL Tallyman controllers are:

IP Address: 192.168.205.121

Subnet Mask: 255.255.255.0

Connection for configuration purposes is via a PC running TallyMan, available for download from the TSL website [www.TSL.co.uk](http://www.TSL.co.uk)

## Initial setup

Connect a PC running a terminal program (Hyper terminal/Putty/Tera Term Pro for example) to the Maintenance Port, Port 3 on the TallyMan controller.

## HyperTerminal Settings

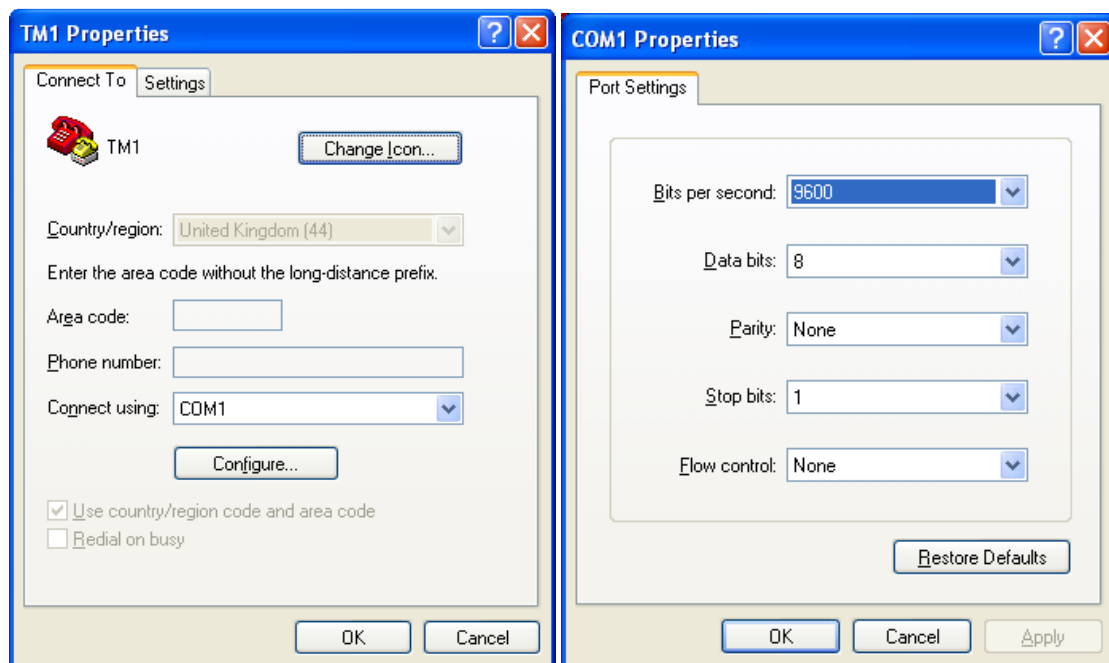

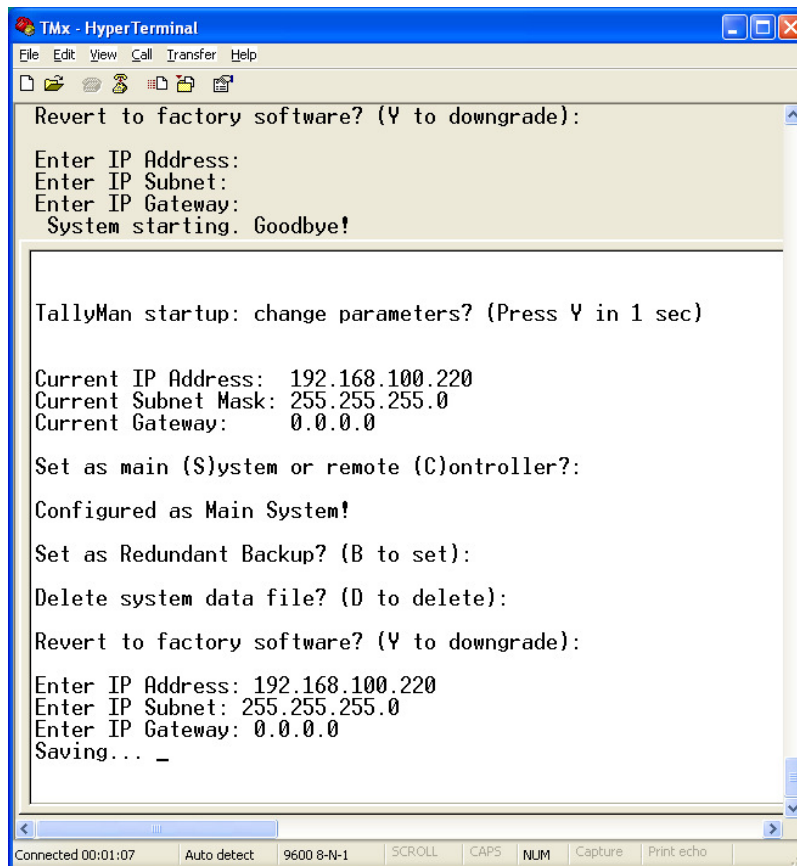

Start HyperTerminal and then power up the TM2+ and wait for about 10 secs. Press Y on the keyboard within 1 sec of the message appearing. Follow the on-screen instruction

- Pressing **S** or Enter on the PC's keyboard will set the TallyMan units as the Main Unit
- Pressing **C** will set it as a Controller so that it may be an Object in the system tree under a Main Controller, this is not necessary to share objects and tally information between controllers, more information on object sharing can be found in the sharing objects section of the TallyMan configuration manual.
- Pressing **B** will set the unit as a Redundant Backup unit. See the section on Backup for information on how to use this facility.
- Pressing **D** will delete the current setup file; pressing any other key will allow access to the IP settings.
- Pressing **Y** will revert the unit to factory software and will downgrade the unit to the previous version of the TallyMan Program provided that an upgrade has taken place in the field.
- IP Addresses are set as shown. If no entry is made and Enter in the PC's keyboard is pressed the original settings will be kept.

When all settings are correct remove the RS232 cable and re-power the unit.

### *Notes.*

Use the following cable to connect your PC comm. Port to Port 3 of the TallyMan:

<b>PC</b>	<b>TM2+</b>
2	3
3	2
5	5

[Back to Top ^](#)

## TMC-1



The TallyMan controller should be installed in a standard 19" rack with good ventilation, no other special precautions need be taken, further information regarding earthing, mounting, power etc may be found in the [Safety](#) section.

### Connections

- Control 1** RS422 – User Assignable. Used for Mixer/Router/Multiviewer connection
- Control 2** RS422 – User Assignable. Used for Mixer/Router/Multiviewer connection
- Controls 3 -18** RS422 – Optional expansion cards. User Assignable. Used for Mixer/Router/Multiviewer connection
- Ethernet** This is for configuration via the configuration PC and network comms with IP capable devices.
- Power** The unit is powered via an IEC 60320 C14 coupler. The inlet is auto ranging 100-240V. No cable is supplied with this device.

## Pin out details

### Ethernet

The cable required to connect the TMC-1 controller with the configuring computer is as follows:

Signal Name	RJ-45 Ethernet Pin Numbers	Crossover Cable Pinouts
TX +	1	3
TX -	2	6
RX +	3	1
FPWR + Power	4	4
FPWR + Power	5	5
RX -	6	2
FPWR - Power	7	7
FPWR - Power	8	8

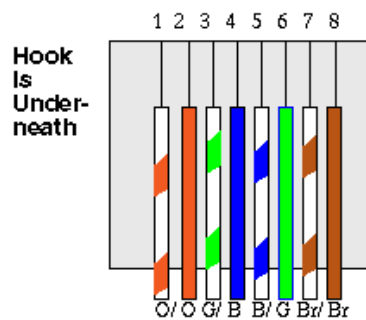

For a hub connection, use a straight-through cable. For TallyMan Controller to Computer, use a crossover cable

[Back to Top ^](#)



## Serial Ports

### Serial Port 1 – RS232

Pin Numbers	Signal	Pin Numbers	Signal
1	DCD	6	DSR
2	RX	7	RTS
3	TX	8	CTS
4	DTR	9	RI
5	0V/Chassis		

### Serial Port 2 – RS422

Pin Numbers	Signal	Pin Numbers	Signal
1	TX-	6	-
2	TX+	7	-
3	RX+	8	-
4	RX-	9	-
5	0v/Chassis		

### Serial Ports 3 -18 – RS422

**Important Note – The pinout of the expansion card RS422 ports will differ from the RS422 serial port 2.**

Different expansion cards have been used over time dependant upon customer demand and availability. The information booklet for the expansion card fitted to your units will be included with your TMC. If you no longer have the information booklet please contact [support@tsl.co.uk](mailto:support@tsl.co.uk) with the serial number of your TMC for details.

## Default IP

The default IP parameters of TSL Tallyman controllers are:

IP Address: 192.168.205.121

Subnet Mask: 255.255.255.0

Connection for configuration purposes is via a PC running TallyMan, available for download from the TSL website [www.TSL.co.uk](http://www.TSL.co.uk)

## Initial setup

Connect a monitor, keyboard and mouse to the VGA and USB ports respectively.

Log into the machine with the default username and password

Default Username: "TSL"

Default Password: "tsl"

Configure the IP address of the TMC-1 via the Network and Sharing centre in the same manner as any Windows 7 machine.

[Back to Top ^](#)

## Specification

### TM1

#### Internal Power Supply Specification

In the event of a failure the faulty item should be returned to TSL for replacement.

The user should not attempt any repairs as this voids the PSU manufacturer's three year warranty.

#### Specifications

Manufacturer's Specification	Model SUU120-180
Input Voltage	90~264 VAC, 47~63 Hz
Input Current	1.0 A @ 230 VAC, 1.7 A @ 115 VAC
Output Voltage	See table below (plus +/-5% adjustment range on O/P 1)
Over Load Protection	110~150% of rated current (auto-recovery)
Over Voltage Protection	112~132% of output voltage (crowbar)
Efficiency	70-88% (dependent on unit)
Line Regulation	0.5% typically
Load Regulation	+/-3% typical on single output units @ 230 VAC input
Hold Up Time	16 ms @ 110 VAC input
Switching Frequency	80 kHz typical
Leakage Current	0.4mA (0.75 mA max.) @ 240 VAC input and full load
Isolation Voltage	I/P-O/P: 3 kVAC, I/P-FG: 1.5 kVAC
Operating Temperature	0 °C to +70 °C (derating by 2.5% /°C above 50 °C)
Safety Standards	UL60950-1, TUV EN60950-1
EMC Standard	EN55022 Class B, EN55024, EN61000-3-2, 3
MTBF	>100 khrs (MIL-HDBK-217F) @ 25 °C
Weight	Approx 0.5 kg each
Dimensions	127(L) x 81.4(W) x 39.2(H)

[Back to Top ^](#)

## TM2

### Internal Power Supply Specification

This is a MeanWell SP-300 Series unit. In the event of a failure the faulty item should be returned to TSL for replacement.

The user should not attempt any repairs as this voids the PSU manufacturer's warranty.

Manufacturer's Specification	Model SP- 300-24
DC Output Voltage	24V
Output Voltage Tolerance	± 1%
Output Rated Current	12.5A
Output Current Range	0 – 12.5A
Ripple and Noise	150mV pk-pk
Line Regulation	± 0.2%
Load Regulation	± 0.5%
DC Output Power	300W
Efficiency	86%
DC Voltage Adjustment	20 ~ 26.4V
Input Voltage Range	88~264VAC 47~63Hz; 124~370VDC
AC Current	4A/115V, 2A/230V
Power Factor	0.9/100~240VAC
Inrush Current	18A/115V 36A/230V
Leakage Current	< 1mA/240VAC
Overload Protection	105~135% Type: Pulsing Hiccup Shutdown Reset: Auto Recovery
Over Voltage Protection	27.6-32.4V
Fan Control Over Temp Protect.	RTH1 or RTH2 > 50°C Fan On, < 45°C Fan Off > 70°C Output Shutdown
Temp. Coefficient	± 0.03%/°C (0~50°C)
Setup, Rise, Hold up Time	1.5s, 50ms, 20ms
Vibration	10~500Hz, 2G 10min./1cycle, Period for 60min each axis
Withstand Voltage	I/P-O/P:3KVAC I/P-FG: 1.5KVAC
Isolation Resistance	I/P-O/P, I/P-FG, O/P-FG:500VDC / 100Mohms
Working Temp. Humidity	-10°C-+50°C (Refer to O/P de-rating Curve), 20%-90% RH
Storage Temp. Humidity	-20°C~+85°C, 10%~95% RH
Dimensions	215*115*50mm Case 912
Module weight	1.2Kgs
Safety Standards	UL1950, TUV EN90950 Approved
EMC Standards	CISPR22 (EN55022), IEC1000-4-2,3,4,5,6,8,11 IEC1000-3-2 Verification
<p>Notes:</p> <ol style="list-style-type: none"> <li>1. All parameters are specified at 230V I/P, rated load, 25°C, 70% RH ambient</li> <li>2. Ripple and noise are measured at 20MHz using a 12" twisted pair terminated with a 0.1uF and 47uF capacitor.</li> <li>3. Line regulation is measured from low line to high line at rated load.</li> <li>4. Load regulation is measured for 0% to 100% rated load.</li> </ol>	

[Back to Top ^](#)



## TM2+

### Internal Power Supply Specification

This is a MeanWell SP-300 Series unit. In the event of a failure the faulty item should be returned to TSL for replacement.

The user should not attempt any repairs as this voids the PSU manufacturer's warranty.

Manufacturer's Specification	Model SP- 300-24
DC Output Voltage	24V
Output Voltage Tolerance	± 1%
Output Rated Current	12.5A
Output Current Range	0 – 12.5A
Ripple and Noise	150mV pk-pk
Line Regulation	± 0.2%
Load Regulation	± 0.5%
DC Output Power	300W
Efficiency	86%
DC Voltage Adjustment	20 ~ 26.4V
Input Voltage Range	88~264VAC 47~63Hz; 124~370VDC
AC Current	4A/115V, 2A/230V
Power Factor	0.9/100~240VAC
Inrush Current	18A/115V 36A/230V
Leakage Current	< 1mA/240VAC
Overload Protection	105~135% Type: Pulsing Hiccup Shutdown Reset: Auto Recovery
Over Voltage Protection	27.6-32.4V
Fan Control Over Temp Protect.	RTH1 or RTH2 > 50°C Fan On, < 45°C Fan Off > 70°C Output Shutdown
Temp. Coefficient	± 0.03%/°C (0~50°C)
Setup, Rise, Hold up Time	1.5s, 50ms, 20ms
Vibration	10~500Hz, 2G 10min./1cycle, Period for 60min each axis
Withstand Voltage	I/P-O/P:3KVAC I/P-FG: 1.5KVAC
Isolation Resistance	I/P-O/P, I/P-FG, O/P-FG:500VDC / 100Mohms
Working Temp. Humidity	-10°C-+50°C (Refer to O/P de-rating Curve), 20%-90% RH
Storage Temp. Humidity	-20°C~+85°C, 10%~95% RH
Dimensions	215*115*50mm Case 912
Module weight	1.2Kgs
Safety Standards	UL1950, TUV EN90950 Approved
EMC Standards	CISPR22 (EN55022), IEC1000-4-2,3,4,5,6,8,11 IEC1000-3-2 Verification
<p>Notes:</p> <ol style="list-style-type: none"> <li>1. All parameters are specified at 230V I/P, rated load, 25°C, 70% RH ambient</li> <li>2. Ripple and noise are measured at 20MHz using a 12" twisted pair terminated with a 0.1uF and 47uF capacitor.</li> <li>3. Line regulation is measured from low line to high line at rated load.</li> <li>4. Load regulation is measured for 0% to 100% rated load.</li> </ol>	

[Back to Top ^](#)

## TMC-1

### Internal Power Supply Specification

This is a Zippy Technology Corp. R1V2-5275V4H power system and is 1+1 redundant power system consisting of two R1V-2275V power modules and one R1V2-5275V4H power system frame. In the event of a failure the faulty item should be returned to TSL for replacement.

The user should not attempt any repairs as this voids the PSU manufacturer's warranty.

Manufacturer's Specification	Model R1V2-5275V4H				
DC Output Voltage	Output voltage	Load Current (A)		Regulation Tolerance	
		Min.	Max.	Max.	Min.
	+5V	0A	20A	+5%	-5%
	+12V	0.1A	22A	+5%	-5%
	-12V	0A	0.3A	+10%	-10%
	+3.3V	0A	20A	+5%	-5%
	5Vsb	0.1A	2.5A	+5%	-5%
Ripple and Noise	+5V	50mV (P-P)			
	+12V	120mV (P-P)			
	-12V	120mV (P-P)			
	+3.3V	50mV (P-P)			
	+5Vsb	50mV (P-P)			
Line Regulation	± 1%				
DC Output Power	275W				
Efficiency	78% ± 2% typical at full load 230VAC				
Input Voltage Range	100~240 VAC full range (with ±10% tolerance)				
AC Current	4A/115V, 2A/230V				
Power Factor Correction	95%/90%, 115/240VAC				
Inrush Current	30/70A, 115/230V (25°C cold start, per power unit)				
Leakage Current	< 3.5mA max at nominal voltage VAC				
Overload Protection	110~170%, Reset: Remove load - cycle power				
Over Voltage Protection	Output Voltage	Min	Typical	Max	
	+3.3V	3.6V	4.1V	4.3V	
	+5V	5.6V	6.1V	6.5V	
	+12V	13.2V	14.3V	15.0V	
Hold up Time	20ms				
Withstand Voltage	I/P-O/P:3KVAC I/P-FG: 1.5KVAC for 60 seconds				
Isolation Resistance	I/P-O/P, I/P-FG, O/P-FG:500VDC / 100Mohms				
Working Temp. Humidity	0°C to 50°C (90~264 VAC, Refer to O/P de-rating Curve), 20%-80% RH				
Storage Temp. Humidity	-20°C~+80°C, 10%~90% RH				
Dimensions	295*106*41.8mm				
Safety Standards	UL 60950, TUV+CB EN90950, CCC GB4943-2001, GB9254-1998, GB17625.1-2003 Approved				
EMC Standards	CISPR22 (EN55022:2006) Class A				

## **Motherboard**

Supplier – Impulse Corp UK

Part number – SBC81205VGG

## **CPU**

Part number - Intel Core 2 Duo E7400 - 2.8Ghz 3Mb Cache 1066 FSB, Dual Core Processor, 775 Socket

## **Memory**

Specification - 2GB, DDR2 SDRAM , 240 pin DIMM, 1.8V

Supplier – Dabs

## **Disk Drive (Solid state)**

Specification – SATA 2 SSD, 30GB

Part number for supplier – OCZSSD2-1VTX30G

Supplier – OCZ Technology

[Back to Top ^](#)



## Safety

### Installation

Unless otherwise stated TSL equipment may be installed at any angle or position within an operating temperature range of 5 ~ 25 degrees C.

The RJ45 connectors are for use only with TSL UMD equipment.

All TSL equipment conforms to the EC Low Voltage Directive:

EC Low Voltage Directive (73/23/EEC) (OJ L76 26.3.73) (LVD).

Amendment: (93/68/EEC) (OJ L220 30.8.93).

### Earthing/Grounding

In all cases, the frame of the equipment should be earthed on installation. Connection to an earthed strip running the length of the frame is ideal.

The earth pin on the IEC mains inlet connector is connected to the metal frame of the equipment, to 0 volts on the internal DC PSU and to signal ground, unless otherwise stated. All metal panels are bonded together. Rack mounted equipment must be earthed (grounded).

### Mounting

Careful consideration of the equipment location and mounting in racks must be made. In particular, consideration must be given to the stability of free-standing racks by mounting heavy equipment low in the rack. The rear of the unit should be supported in the rack.

### Power

For pluggable equipment, the socket outlet shall be installed near the equipment and shall be easily accessible.

Consideration must be given to the supply circuit loading and switch on/fault surges that will affect over current protection trips and switches etc.

Check that the fuse rating is correct for the local power (mains) supply. Replacement fuses must be of the same rating and type for continued protection against fire risk.

The equipment rating is shown on the rear panel.

No power supply cord is provided with this equipment.

**Do not switch on until all connections are made.**

### Ventilation

Due consideration for cooling requirements must be given when mounting the equipment.

If the equipment is installed in a closed unit, consideration must be given to providing forced air cooling in order that the maximum recommended temperature is not exceeded. Introduction 9 TallyMan V 1.7.1b on

[Back to Top ^](#)

## EC Declaration of conformity

### EC DECLARATION OF CONFORMITY

Application of Council Directives Nos:

EC Low Voltage Directive (73/23/EEC)(OJ L76 26.3.73)(LVD).

Amendment: (93/68/EEC) (OJ L220 30.8.93).

Conformity Standards Declared:

EN 60950

EMC Directive: 89/336/EEC, Amended 92/31/EEC.

Conformity Standards Declared:

EN 50081-1, EN 50082-1

Manufacturer's Name: Television Systems Ltd

Manufacturer's Address: Vanwall Road

Maidenhead SL6 4UB

England

United Kingdom

Type of Equipment: UMD System Controller

Model No: UMD TM1 / TM2 / TM2 PLUS / TMC-1

Part Number: TSLP- UMD TM1 / TM2 / TM2 PLUS / TMC-1

Date CE Mark Affixed: 2006/2009

I, the undersigned, declare that the equipment specified above conforms to the quoted Directives and Standards.

Place: Maidenhead, England

Signature:

Date: \_\_\_\_\_

Print: J F PINNIGER

Position: PRODUCT MANAGER

[Back to Top ^](#)

## Warranty, Maintenance and Repair

All TSL equipment is guaranteed for one year from the date of delivery to the customer's premises. If the equipment is to be stored for a significant period, please contact TSL concerning a possible extended warranty period.

### Failure during warranty

If any TSL product should fail or become faulty within the warranty period, first please check the PSU fuses.

All maintenance work must be carried out by trained and competent personnel.

### Technical support information

E-Mail address: [support@tsl.co.uk](mailto:support@tsl.co.uk)

Telephone Support Number: +44 (0) 1628 564610

If equipment has to be returned to TSL for repair or re-alignment, please observe the following:

### TSL Returns Procedure

Please email [Support@TSL.co.uk](mailto:Support@TSL.co.uk) or telephone +44 (0)1628 564610 and ask for Technical Support who will assist in diagnosing the fault and will provide a Returns Number (RMA). This will enable us to track the unit effectively and will provide some information prior to the unit arriving.

For each item, this unique Returns Number must be included with the Fault Report sent with the unit.

A contact name and telephone number are also required with the Fault Report sent with the unit.

### Fault report details required

- Company:
- Name:
- Address:
- Contact Name:
- Telephone No:
- Returns Number:
- Symptoms of the fault (to include switch setting positions, input signals etc):

### Packing

Please ensure that the unit is well packed as all mechanical damage is chargeable. TSL recommends that you insure your equipment for transit damage.

The original packaging, when available, should always be used when returning equipment.

**If returned equipment is received in a damaged condition, the damage should be reported both to TSL and the carrier immediately.**

[Back to Top ^](#)